

CHARACTERISTICS

		STANDARD	AVAILABLE OPTIONS
Technology		Eccentric Disc Mouvex®	
Flow rate at 1 cSt m³/h (GPM)		1.23 (5.41)	
Displacement l (gal)		0.066 (0.0174)	
Internal relief valve		Yes	
Pump per unit		1	2 with by-passing valves
Ports		Flanges	
Heating		No	
Dimensions mm (in.)	A	246 (9.685)	
	B	320 (12.600)	
	C	470 (18.504)	
	D	137 (5.394)	
	E	540 (21.260)	
	F	712 (28.031)	
	G	200 (7.874)	
H	763 (30.039)		
Weight kg (lbs)		27 (59.53)	With 2 pumps 72 (158.73)

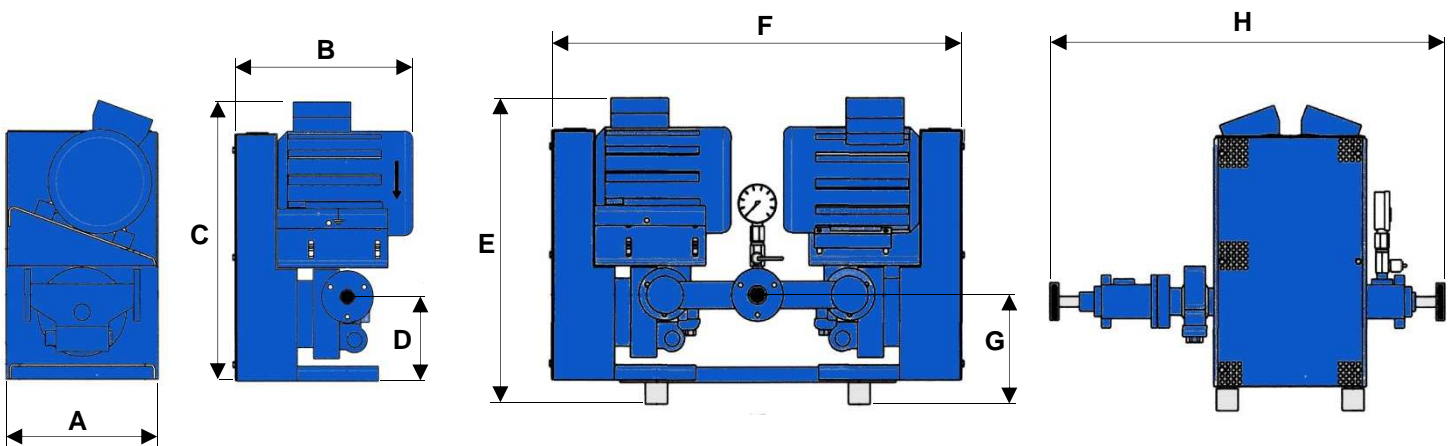

OPERATING LIMITS

	STANDARD MATERIALS
Minimum temperature °C (°F)	-10 (14)
Maximum temperature °C (°F)	80 (176)
Maximum viscosity cSt (SSU)	1000 (4637)
Maximum differential pressure bar (psi)	5 (72)
Maximum speed (rpm)	700

MATERIALS OF CONSTRUCTION

PART NAME	STANDARD MATERIALS	AVAILABLE OPTIONS
Casing	Cast Iron	
Cylinder	Cast Iron	
Disc	Cast Iron	
Front cover	Cast Iron	
Shaft	Carbon steel	
Bushings	Hardened iron	
Static O-rings	FKM	
Mechanical seal	Bronze / Stainless FKM O-rings	